8903/FA FireWire IEEE 1394a Communications Option

Technical Manual
HA469265U001 Issue 6

© Copyright 2011 Parker Hannifin Ltd.

All rights strictly reserved. No part of this document may be stored in a retrieval system, or transmitted in any form or by any means to persons not employed by a Parker Hannifin Ltd., Automation Group, SSD Drives Europe without written permission from Parker Hannifin Ltd., Automation Group, SSD Drives Europe. Although every effort has been taken to ensure the accuracy of this document it may be necessary, without notice, to make amendments or correct omissions. Parker Hannifin Ltd., Automation Group, SSD Drives Europe cannot accept responsibility for damage, injury, or expenses resulting there from.

WARRANTY

Parker Hannifin Ltd., Automation Group, SSD Drives Europe, warrants the goods against defects in design, materials and workmanship for the period of 24 months from the date of manufacture, or 12 months from the date of delivery (whichever is the longer period) on the terms detailed in Parker SSD Drives Standard Conditions of Sale IA500504.

Parker Hannifin Ltd., Automation Group, SSD Drives Europe reserves the right to change the content and product specification without notice.

FAILURE OR IMPROPER SELECTION OR IMPROPER USE OF THE PRODUCTS DESCRIBED HEREIN OR RELATED ITEMS CAN CAUSE DEATH, PERSONAL INJURY AND PROPERTY DAMAGE.

This document and other information from Parker-Hannifin Corporation, its subsidiaries and authorized distributors provide product or system options for further investigation by users having technical expertise.

The user, through its own analysis and testing, is solely responsible for making the final selection of the system and components and assuring that all performance, endurance, maintenance, safety and warning requirements of the application are met. The user must analyze all aspects of the application, follow applicable industry standards, and follow the information concerning the product in the current product catalog and in any other materials provided from Parker or its subsidiaries or authorized distributors.

To the extent that Parker or its subsidiaries or authorized distributors provide component or system options based upon data or specifications provided by the user, the user is responsible for determining that such data and specifications are suitable and sufficient for all applications and reasonably foreseeable uses of the components or systems.

Safety Information



Requirements

IMPORTANT: Please read this information BEFORE installing the equipment.

Intended Users

This manual is to be made available to all persons who are required to install, configure or service equipment described herein, or any other associated operation.

The information given is intended to highlight safety issues, EMC considerations, and to enable the user to obtain maximum benefit from the equipment.

Complete the following table for future reference detailing how the unit is to be installed and used.

INSTALLATION DETAILS	
Model Number <i>(see product label)</i>	
Where installed <i>(for your own information)</i>	
Unit used as a: <i>(refer to Certification for the Inverter)</i>	<input type="radio"/> Component <input type="radio"/> Relevant Apparatus
Unit fitted:	<input type="radio"/> Wall-mounted <input type="radio"/> Enclosure



Application Area

The equipment described is intended for industrial motor speed control utilising DC motors, AC induction or AC synchronous machines

Personnel

Installation, operation and maintenance of the equipment should be carried out by qualified personnel. A qualified person is someone who is technically competent and familiar with all safety information and established safety practices; with the installation process, operation and maintenance of this equipment; and with all the hazards involved.

Product Warnings

	Caution Risk of electric shock		Caution Refer to documentation		Earth/Ground Protective Conductor Terminal
---	--	---	--	---	--

Safety Information



Hazards

DANGER! - Ignoring the following may result in injury

1. This equipment can endanger life by exposure to rotating machinery and high voltages.
2. The equipment must be permanently earthed due to the high earth leakage current, and the drive motor must be connected to an appropriate safety earth.
3. Ensure all incoming supplies are isolated before working on the equipment. Be aware that there may be more than one supply connection to the drive.
4. There may still be dangerous voltages present at power terminals (motor output, supply input phases, DC bus and the brake, where fitted) when the motor is at standstill or is stopped.
5. For measurements use only a meter to IEC 61010 (CAT III or higher). Always begin using the highest range. CAT I and CAT II meters must not be used on this product.
6. Allow at least 5 minutes for the drive's capacitors to discharge to safe voltage levels (<50V). Use the specified meter capable of measuring up to 1000V dc & ac rms to confirm that less than 50V is present between all power terminals and earth.
7. Unless otherwise stated, this product must NOT be dismantled. In the event of a fault the drive must be returned. Refer to "Routine Maintenance and Repair".

WARNING! - Ignoring the following may result in injury or damage to equipment

SAFETY

Where there is conflict between EMC and Safety requirements, personnel safety shall always take precedence.

- Never perform high voltage resistance checks on the wiring without first disconnecting the drive from the circuit being tested.
- Whilst ensuring ventilation is sufficient, provide guarding and /or additional safety systems to prevent injury or damage to equipment.
- When replacing a drive in an application and before returning to use, it is essential that all user defined parameters for the product's operation are correctly installed.
- All control and signal terminals are SELV, i.e. protected by double insulation. Ensure all external wiring is rated for the highest system voltage.
- Thermal sensors contained within the motor must have at least basic insulation.
- All exposed metalwork in the Inverter is protected by basic insulation and bonded to a safety earth.
- RCDs are not recommended for use with this product but, where their use is mandatory, only Type B RCDs should be used.

EMC

- In a domestic environment this product may cause radio interference in which case supplementary mitigation measures may be required.
- This equipment contains electrostatic discharge (ESD) sensitive parts. Observe static control precautions when handling, installing and servicing this product.
- This is a product of the restricted sales distribution class according to IEC 61800-3. It is designated as "professional equipment" as defined in EN61000-3-2. Permission of the supply authority shall be obtained before connection to the low voltage supply.

CAUTION!

APPLICATION RISK

- The specifications, processes and circuitry described herein are for guidance only and may need to be adapted to the user's specific application. We can not guarantee the suitability of the equipment described in this Manual for individual applications.

RISK ASSESSMENT

Under fault conditions, power loss or unintended operating conditions, the drive may not operate as intended.

In particular:

- Stored energy might not discharge to safe levels as quickly as suggested, and can still be present even though the drive appears to be switched off
- The motor's direction of rotation might not be controlled
- The motor speed might not be controlled
- The motor might be energised

A drive is a component within a drive system that may influence its operation or effects under a fault condition.

Consideration must be given to:

- Stored energy
- Supply disconnects
- Sequencing logic
- Unintended operation

Contents

Contents

Page

FIREWIRE COMMUNICATIONS OPTION	1
Introduction	1
Product Features	1
Product Order Code.....	1
Compatible Firmware.....	1
Restrictions.....	1
Installation.....	2
Wiring the System.....	5
Terminology	5
Powering the Node	5
Connecting the Nodes.....	5
Extenders.....	6
Initial Set-up.....	8
Configuring the 890 Drive.....	8
Status LED Indications	9
Disposal	9

FIREWIRE COMMUNICATIONS OPTION

Introduction

This manual describes the Parker SSD Drives' FireWire® Communications Interface Option.

Product Features

Note: FireWire is also known as IEEE1394 and is a high speed peer-to-peer serial bus.

- Suitable for use with 890CD Common Bus Drive, 890SD Standalone Drive and 890PX Drive.
- LED to indicate option and communications status
- Plug-and-play operation. No user settings required

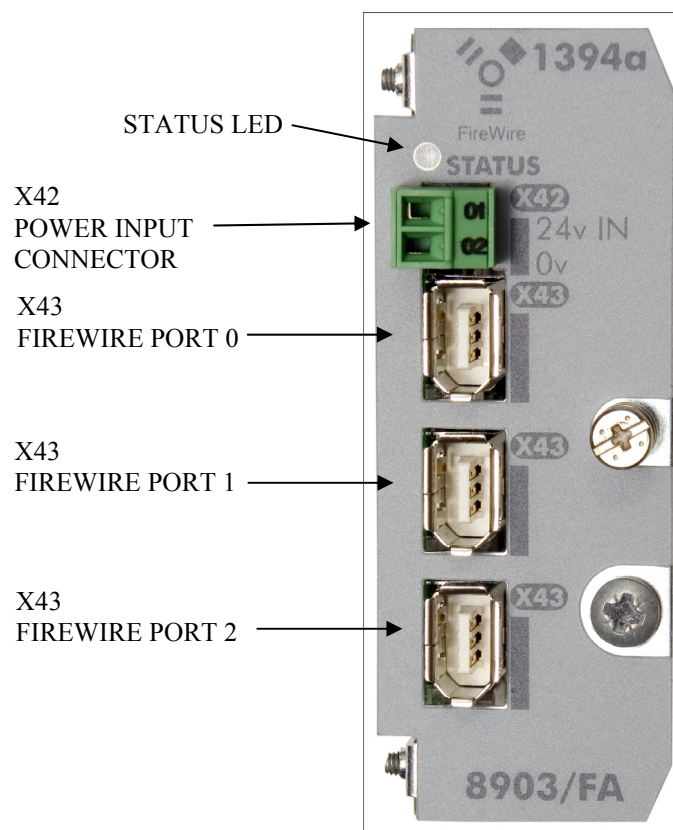

Figure 1. Front of the 8903/FA FireWire Communications Interface Option (Option)

Product Order Code

Not fitted order code: 8903-FA-00

Factory fitted order code: 890xx-xxxxxxxx-xxx-xxxxA

Compatible Firmware

This option will work with all versions of 890 firmware.

Restrictions

Option must be fitted in Slot B.

Installation

WARNING!

Before installing, ensure that the drive wiring is electrically isolated and cannot be made "live" unintentionally by other personnel. Wait 5 minutes after disconnecting power before working on any part of the system or removing the covers from the drives.

To Remove the Control Board

1. Remove the blanking plates, each secured by a single screw, that fits over the option slots (1).
2. Loosen the top and bottom screws from the handles of the Control Board (2).
3. Pull gently on the handles and slide the Control Board out of the drive.

Note: Save the blanking plate and screw for future use. The drive should not be operated without either an option or blanking plate fitted. When fitted, these maintain the drive's IP20 rating.

Caution

This Option contains ESD (Electrostatic Discharge) sensitive parts. Observe static control precautions when handling, installing and servicing this Option.



Figure 2. 890 showing Control Board withdrawn with Options fitted

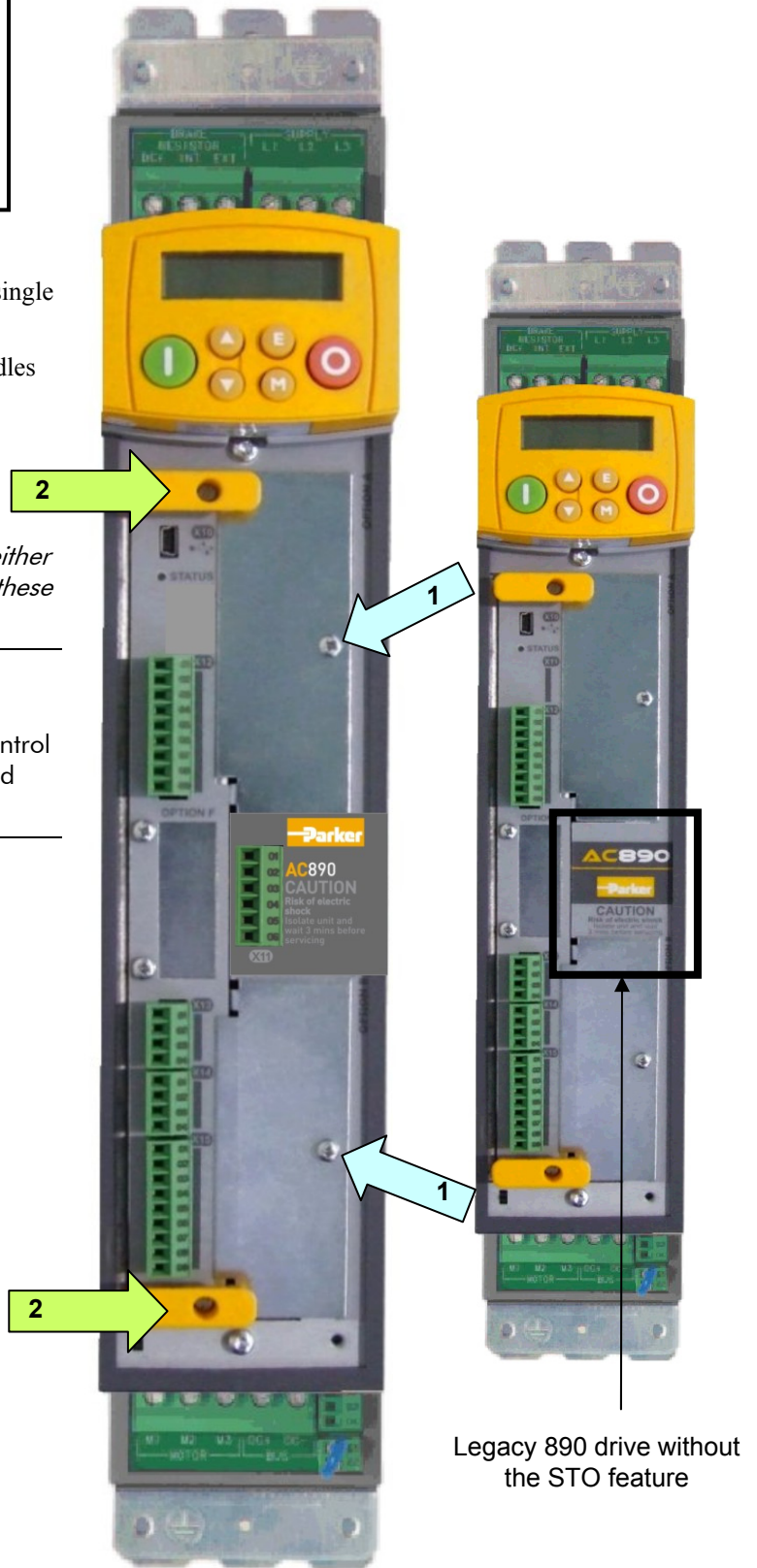

Legacy 890 drive without the STO feature

Figure 3. Front of 890 drive showing Control Board fitted

Fitting the Option

The Option fits on to the Control Board.

1. Insert the connector into the Option as shown. The legs of the connector will protrude through into the connector on the other side of the Option.
2. Press the assembly into the **BOTTOM** connector (adjacent to terminals X13, X14 and X15) on the Control Board. Ensure that the front panel of the Option overlaps the front of the Control Board.

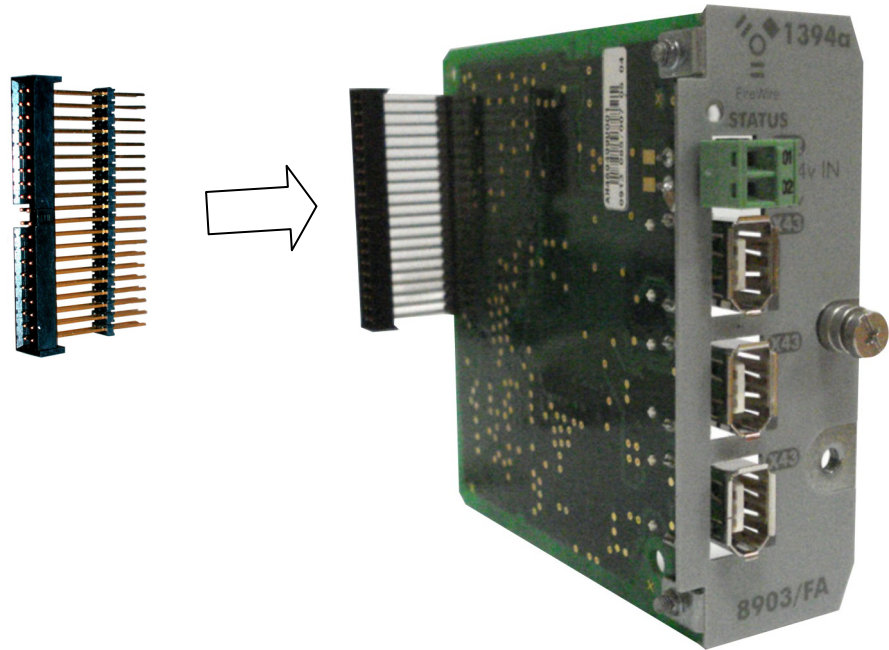

Figure 4. Fitting the connector to the Option

Re-fitting the Control Board

1. Slide the board into the drive, engaging the edges of the boards into the slots. Push until the back edge of the Control Board PCB locates with the connectors in the drive.
2. Tighten in position using the top and bottom screws in the handles of the Control Board.
3. Screw the Option in position using the captive screw on the front of the Option.

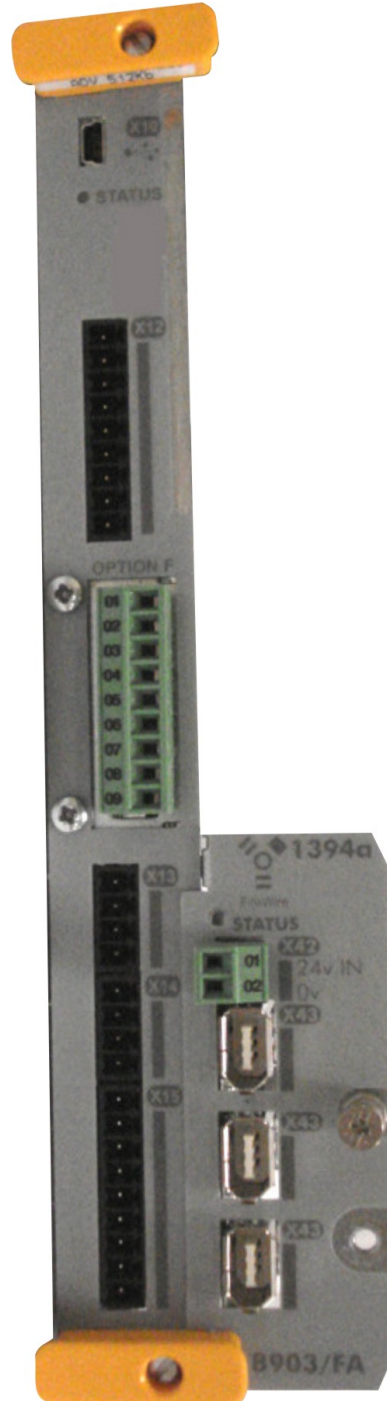

Figure 5. 890 Control Board with FireWire Communications Option fitted

Wiring the System

Terminology

Node :	Any single piece of IEEE1394 connected apparatus
Bus :	The network of interconnected IEEE1394 nodes
Hop :	Any single IEEE1394 interconnecting cable
Lonely :	No other active nodes detected

Powering the Node

IMPORTANT: DO NOT power the Option using the drive's 24V.

The IEEE1394 bus requires a **separate, floating** 24Vdc (12-24Vdc) supply connected to the Power Input Connector, terminal X42.

As a guide, each node may take up to 20mA at 24V from this supply. A node will draw more current at lower supply voltages, for example, a node may draw up to 40mA using a 12V supply.

Supply 24Vdc to one of the nodes on the bus. The 24Vdc is transferred to other nodes on the bus via the IEEE1394 cable.

Pin 01 = 24V
Pin 02 = 0V

If you do power more than one node on the same bus (for instance, one supply in each of two enclosures allowing for one of the enclosures to be isolated yet maintaining the bus), the supplies must again be **separate, floating** supplies.

Connect the 24V supply to the X42 terminal block using twisted pair cable.

Connecting the Nodes

Use an IEEE 1394a cable to connect two nodes together. These cables are considered electrically sensitive. In electrically noisy environments, FireWire messages may be corrupted. If this occurs, the system will automatically recover by restarting the communications. This process is called a Bus Reset and can take up to 0.5 seconds to complete. During this time data will not be transferred by the bus.

To avoid Bus Resets, keep electrically noisy and sensitive cables apart. Pay particular attention to screening and earthing of motor cables. Where necessary, sensitive cables should cross noisy cables at 90° to minimise capacitive coupling.

(The occurrence and frequency of Bus Resets can be monitored from the keypad).

The quality of RF earthing is important when using FireWire systems. In noisy environments, it is recommended that each drive front plate is strapped to an adjacent drive using a copper braid, to ensure a low impedance path for RF signals.

If some drives are mounted remotely, it is recommended that the FireWire cable between the drives is fitted with a ferrite RF absorption clamp (SSD Part Number : DJ467799).

We can supply the following recommended cables:

SSD Part Number	Cable Length
CM469189U002	0.2m
CM469189U003	0.28m
CM469189U010	1m
CM469189U045	4.5m
CM469189U100	10m

If using 10m cables, note that an additional limitation applies: the cable length limit between the two most distant nodes on the network is 72m. 10m cables should be used sparingly, and short (1m) cables should be used wherever possible to ensure this limit is not exceeded. See "Extenders" below.

Each port is interchangeable – any message transmitted by the node exits all three ports. Any message received on one port is repeated on the other two ports.

Nodes can be connected in a Daisy Chain or a Tree configuration but loops are not allowed.

The maximum number of hops between the most distant nodes on the network is 16, so for 17 or more nodes a Tree is essential. The maximum number of nodes is 63. Refer to Figure 6 on next page.

Note: The network power draw is approximately 20mA per node at 24V, approximately 40mA at 12V. Note that 63 nodes at 24V (20mA per) is 1.26A total. The power system has thermally self-resetting fuses for 1.5A. So, at 12V it is not possible to wire for more than 37 nodes reliably.

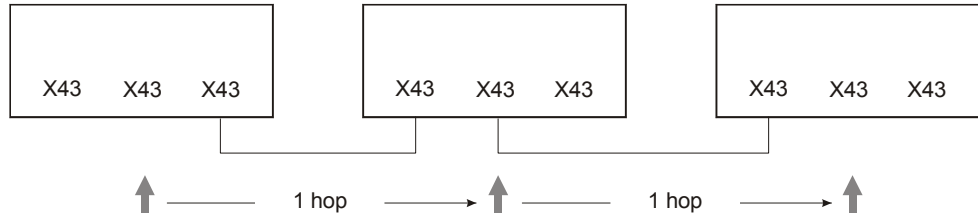

Daisy Chain Configuration

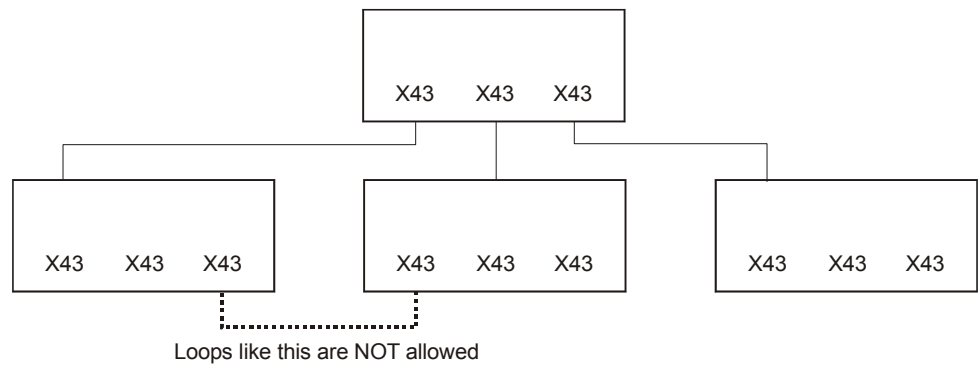

Tree Configuration

Extenders

If any hop needs to be longer than 10m, then an extender is required to repeat the bus over CAT5 cable or optical fibre. There are commercially available units such as:

www.exprodirect.com/firewire-cables/ FW2UTP-01 1x IEEE1394a port, 1xRJ45 CAT5 port
or FW2UTP-02A 1x IEEE1394a port, 2xRJ45 CAT5 port
www.amazon.co.uk FW2UTP-02B 1x IEEE1394a port, 2xRJ45 CAT5 port

Any 2 of the above can be used with a CAT5 crossover cable of up to 100m.

www.newnex.com ... FireNex-MX (TM) 2xIEEE1394a ports, 1x optical duplex LC port

Two of the above can be used with 100m of LC to LC ,62.5125um, multi-mode optical cable.

EXAMPLE HOP COUNT BETWEEN MODULES		
DRIVE-DRIVE	HOPS	HOPS
1	12	11
1	13	12
1	37	14
1	47	14
25	37	15
36	47	16

EXAMPLE 4 RACK
47 DRIVE NETWORK

NOTES

1. MAXIMUM NUMBER OF HOPS, OR CABLES, BETWEEN ANY TWO NODES, MUST BE <=16.
2. 48 DRIVES WOULD VIOLATE WITH 17 HOP, UNLESS MORE BRANCHING AT A LOWER LEVEL WAS DONE, I.E. MORE SMALLER RACKS, OR BREAKING RACKS INTO MULTIPLE BRANCHES.

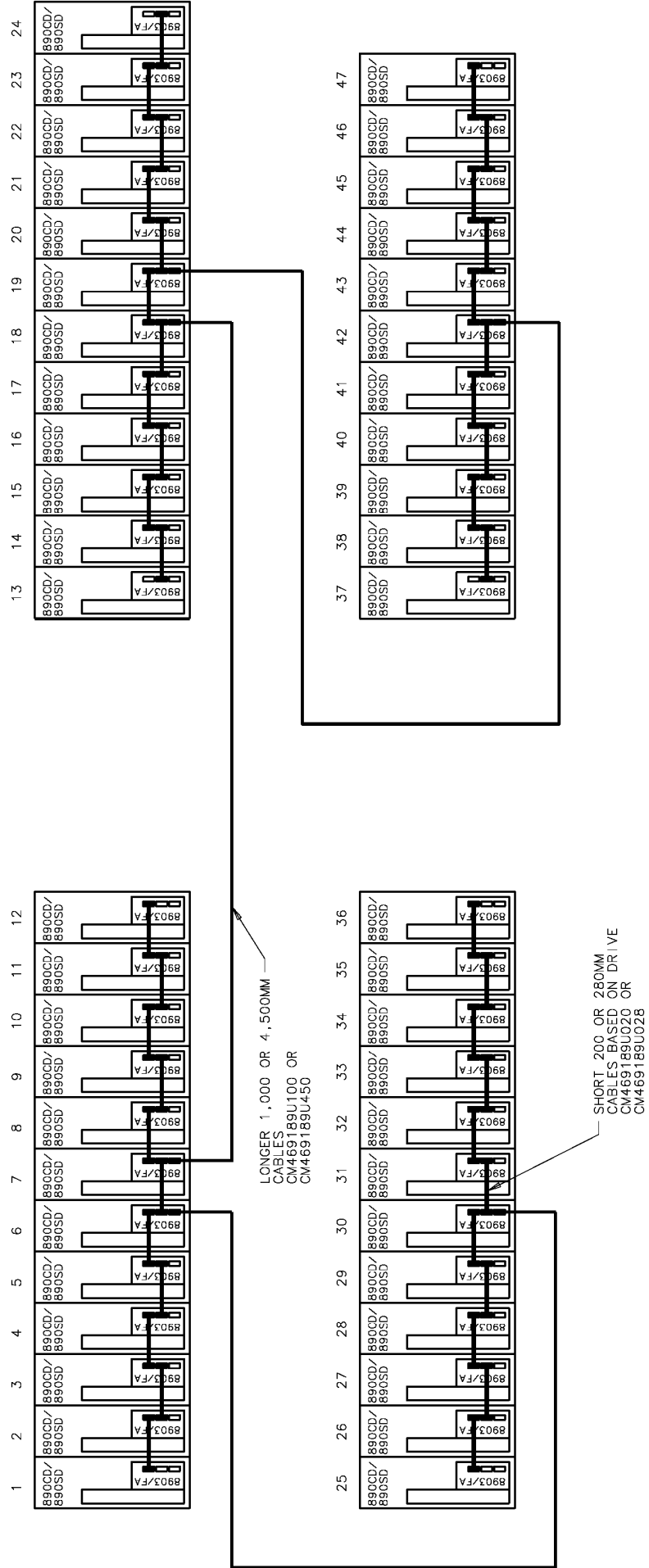

Figure 6. Example 4 Rack, 47 Drive Network

Initial Set-up

Configuring the 890 Drive

All drives in the system MUST be fitted with a FireWire Option that is wired correctly.

The FireWire Option is plug-and-play, requires no setting-up, and can be used in the following ways:

1. The Drive may exchange data with other Drives using Network inputs and outputs configured using DSE.
2. **DSE** : use FireWire to connect DSE to all drives in the system.
3. **Peer-To-Peer** : use FireWire to link drive parameters.
4. **Virtual Axis** : use FireWire to broadcast synchronised information to all drives on the system (e.g. a shaftless printing application).

You can use the diagnostics provided in the FIREWIRE block to see your system at work.

FIREWIRE

SETUP::COMMS::FIREWIRE

The FireWire block parameterises FireWire communications, providing a series of diagnostics. There are no user settable parameters in this block.





Parameter Descriptions

OWN ID	<i>PREF: 117.01</i>	<i>Default: 99</i>	<i>Range: —.</i>
FireWire network ID of the drive. This is the physical address, not the net address, as declared as part of the DSE Configuration. Note that this network ID can change after a Bus Reset.			
IRM ID	<i>PREF: 117.02</i>	<i>Default: 99</i>	<i>Range: —.</i>
FireWire network ID of the drive acting as the Isochronous Resource Manager. The IRM ID can change after a Bus Reset.			
NUMBER OF NODES	<i>PREF: 117.03</i>	<i>Default: 0</i>	<i>Range: —.</i>
Total number of FireWire Nodes connected to the network..			
CYCLE TIMER	<i>PREF: 117.04</i>	<i>Default: 0</i>	<i>Range: —.</i>
Timer which should be synchronised across the FireWire network.			
BUS RESETS	<i>PREF: 117.05</i>	<i>Default: 0</i>	<i>Range: —.</i>
Number of times the FireWire bus has reset since power-on.			
MY BUS RESETS	<i>PREF: 117.15</i>	<i>Default: 0</i>	<i>Range: —.</i>
Number of Bus Resets initiated by this node. An incrementing value may indicate that the Firewire cabling needs attention.			
BAD MESSAGES	<i>PREF: 117.13</i>	<i>Default: 0</i>	<i>Range: —.</i>
Number of incoming Firewire messages that are received malformed. An incrementing value may indicate that the Firewire cabling needs attention.			
MCAP ADVERTS	<i>PREF: 117.06</i>	<i>Default: 0</i>	<i>Range: —.</i>
Count of Multicast Advertisements received by this node.			
MAX HOPS	<i>PREF: 117.07</i>	<i>Default: 0</i>	<i>Range: —.</i>
Maximum number of cable hops between the two most distant nodes on the network.			
OFFSET (40.69ns)	<i>PREF: 117.08</i>	<i>Default: 0</i>	<i>Range: —.</i>
Time delay between this node and the node hosting the Cycle Time Master.			

The DSE Configuration Tool is Parker SSD Drives' Windows-based block programming software and is supplied with each 890 drive.

Status LED Indications

The Status LED on the Option indicates the following states:

Flash Sequence	Bus State
 50-50 OFF-RED	No Bus Power
 100 AMBER	Bus Reset
 50-50 OFF-GREEN	Bus Power On, only drive
 5-95 OFF-GREEN	Bus Running, multiple drives

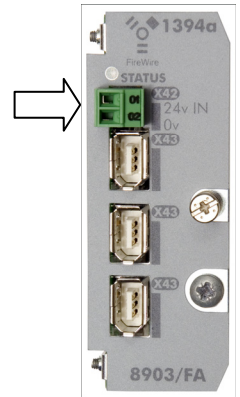

Disposal

This product contains materials which are consignable waste under the Special Waste Regulations 1996 which complies with the EC Hazardous Waste Directive - Directive 91/689/EEC.

We recommend you dispose of the appropriate materials in accordance with the valid environmental control laws. The following table shows which materials can be recycled and which have to be disposed of in a special way.

Material	Recycle	Disposal
metal	yes	no
plastics material	yes	no
printed circuit board	no	yes

The printed circuit board should be disposed of in one of two ways:

1. High temperature incineration (minimum temperature 1200°C) by an incinerator authorised under parts A or B of the Environmental Protection Act
2. Disposal in an engineered land fill site that is licensed to take aluminium electrolytic capacitors. Do not dispose of in a land fill site set aside for domestic waste.

Packaging

During transport our products are protected by suitable packaging. This is entirely environmentally compatible and should be taken for central disposal as secondary raw material.

